

# PTM SERIES

## Modern Luminaire

Type:

Fixture:



\*POLES, MOUNTING BRACKETS AND CONTROL OPTIONS SOLD SEPARATELY

### TECHNICAL DATA

PRODUCT	PTM-100L	PTM-180L
WATTAGE	50W-80W	100W-150W
LUMENS	UP TO 10,000 LM	UP TO 18,000 LM
EFFICACY	UP TO 120 LM/W	
CCT	3000K, 4000K, 5000K	
VOLTAGE	120 - 277V, 347V - 480V	
CONTROL	BI-LEVEL/ DAY HARVESTING, NEMA TWIST LOCK PHOTO CONTROL	
CRI	>70	
DIMMING	YES	
LENS	CLEAR, FROSTED	
IP RATING	IP65	
SURGE PROTECTION RATING	10 KV/ 5 KA	
WORKING TEMP.	-40°F ~ 122°F	

### DESCRIPTION

The Modern Luminaire is a medium scale outdoor luminaire featuring slim cylindrical cast aluminum housing with powder coating finish. It is aesthetically designed to be used for a wide variety of outdoor applications such as pathway, recreational & perimeter illumination. PTM is available in 2 lumen packages for different mounting height, 3 different color temperature from warm white to cold white and multiple mounting options. PTM's elegant design and pedestrian-friendly illumination elevate the experience of occupant in today's urban pedestrian spaces.

### INTENDED USE

PTM is ideal for use illuminating building entryways, walking paths, pedestrian plazas, courtyards, outdoor retail locations, universities and historical sites.



### ORDERING INFORMATION

STANDARD ITEM: **PTM-100L-U-50K-T5-CL-D10-BK**

OR CUSTOMIZE BELOW:

<input type="text"/>	-	<input type="text"/>	-	<input type="text"/>	-	<input type="text"/>	-	<input type="text"/>	-	<input type="text"/>	-	<input type="text"/>
SERIES	Lumen Package	Voltage	CCT	OPTICS	LENS	CONTROL	FINISH					
PTM - (Modern Luminaire)	100L - (10000 lm, 80W) 180L - (18000 lm, 150W)	U - (120 - 277V) H - (347 - 480V)*	30K - (3000K)* 40K - (4000K) 50K - (5000K)	T3 - (Type 3)* T5 - (Type 5)	FR - (Frosted)* CL - (Clear)	D10 - (0-10 Dimming)	BK - (Black) RAL - (RAL Custom Color)*					

\*Customized Product. May cause additional lead time.

### OPTIONAL ACCESSORY ORDERING INFORMATION

CONTROL OPTIONS		MOUNTING
7P - (7-pin receptacle w/ short cap)	TL7-B2 - (110-277V Twist Lock)	Y - (Post Top Mount)
7C - (7-pin receptacle w/ on-off photocell)	TL7-HVG - (110-480V Twist Lock)	WP - (Pole Mount/ Wall Mount))
MS - (Motion Sensor)		

## Modern Luminaire

Type:

Fixture:

### FEATURES

#### CONSTRUCTION

One-piece low copper die-casting aluminum alloy housing. PC optic with tempered glass lens can be chosen between frosted or clear. Impact rating at IK08. Driver compartment with seamless silicone gaskets to an IP65 enclosure rating. Tool-less entry into driver compartment from the top.

#### FINISH

Exterior parts are protected by polyester powder coating finish that provides superior resistance to corrosion for maximum retention of gloss and luster. A tightly controlled multi-stage process ensures a minimum 3-mil thickness for a finish that can withstand the elements without cracking or peeling.

#### OPTICS

The engine optic shall be one-piece, injection molded, non-yellowing Impact resistant PC, sealed top and bottom with seamless silicone gaskets to an IP65 rating. Light engines are available in 3000K, 4000K or 5000K @ 70+CRI.

#### ELECTRICAL

Light engines consist of high-efficacy LEDs mounted to deliver 100 lumen per watt while maintain a promote long life of L70 > 100,000 hours. Class 2 outdoor rated LED drivers are designed for an expected life of over 50,000 hours.

#### LISTINGS

ETL certified. RoHs compliant, Luminaire is IP65 & IK08 rated.

### MOUNTING OPTION

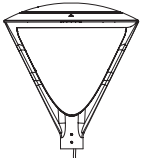

**PTM-Y-MOUNT**  
Y Mount  
(Post Top)

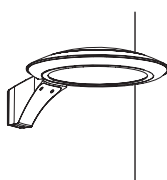

**PTM-WP-MOUNT**  
Wall Mount

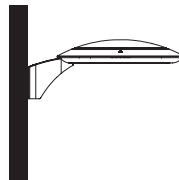

**PTM-WP-MOUNT**  
Round Pole Mount  
Square Pole Mount

### DIMENSIONS

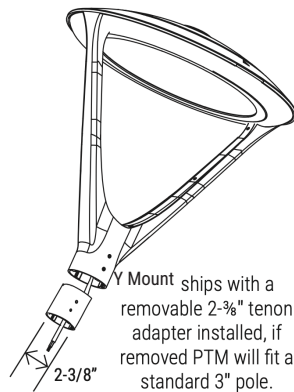
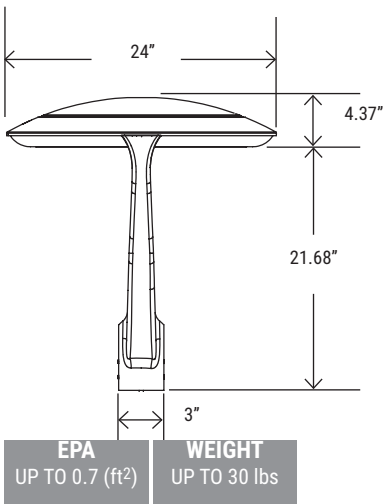

### DISTRIBUTION

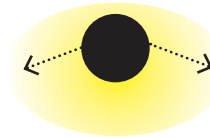

#### TYPE III

Type III distribution provides a wide, round pattern and yields an even light disbursement since the light projects' outwards.

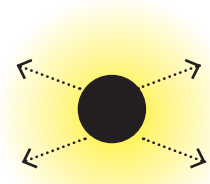

#### TYPE V

Type V provides central circular or square design pattern, equally across all angles from a central point.