

DEFENDER SERIES

Vandal Resistant Luminaire

Type:

Fixture:

TECHNICAL DATA



PRODUCT	DF-10-25W			DF-14-30W		
RATED WATTAGE	25W			30W		
TEST WATTAGE	23W			23W		
LUMENS	2838 @ 30K	3094 @ 40K	2944 @ 50K	3708 @ 30K	3838 @ 40K	3790 @ 50K
LUMENS WITH VISOR	1407 @ 30K	1557 @ 40K	1476 @ 50K	1822 @ 30K	1941 @ 40K	1901 @ 50K
EFFICACY	122.5	135	127	126.5	137	131
EFFICACY WITH VISOR	63	69	66	61	68	64
CC	3000K/4000K/5000K Color Changeable					
VOLTAGE	100V-277V					
CRI	>80					
LIFETIME (L70)	>50,000					
LED TYPE	2835 SMD LED / 8W					

DESCRIPTION

The Defender Series Vandal Resistant fixture is one of the most versatile lights in the industry. With its robust and tamper-proof construction, it can illuminate any area subject to abuse and weather of any type. Multiple mounting and lens configurations lend it to be used on a ceiling or wall. Peace of mind and eye-pleasing aesthetics compliments the design.

INTENDED USE

The Defender series is ideal for illuminating alleyways, rear entrances of businesses, detention (prison) areas indoor and out, school building faces, apartment exterior hallways, and yards. Any areas subject to repeated abuse or bad weather.



ORDERING INFORMATION

STANDARD ITEM: **DF-14-30W-CC-BK**

OR CUSTOMIZE BELOW:

<input type="text"/>	-	<input type="text"/>	-	<input type="text"/>	-	<input type="text"/>	-	<input type="text"/>
Series		Size		Wattage		CC (Color changeable)		Color
DF - Defender Vandal Resistant Series		10 - (10" Diameter) 14 - (14" Diameter)		25W 30W		CC - Color Changeable (3000K/4000K/5000K)		BK (Black) RAL (Custom)*

SLIDE SWITCH

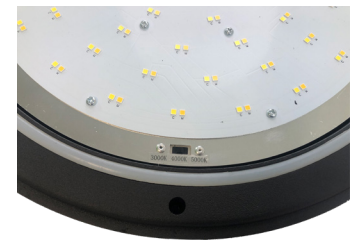

COLOR CHANGEABLE (3000K/4000K/5000K)

*Contact your sales representative for more information.

DEFENDER SERIES

Vandal Resistant Luminaire

Type:

Fixture:

CONSTRUCTION

Shallow casting is die-cast aluminum. Backplate constructed of 16 gauge aluminum.

FINISH

Rust and corrosion proof with polyester powder coating.

LENS

Lens limited-lifetime warranty.

ELECTRICAL

Class 2, constant current, 100V-277V, 50-60 Hz.

LISTINGS

ETL certified. Luminaire is IP65 rated.

DECORATIVE FACES

High-impact aluminum overlay attached to lens with four recessed T20 stainless steel TORX®-head fasteners. Open face is lens for continuous radial light pattern.

GASKET

Die-cut closed-cell silicone gasket seals lens to casting. Gasket is secured with adhesive, and locked in place to the back casting. When the casting is not required, the gasket is mechanically attached to the back plate. One gasket seals the fixture.

MOUNTING

Surface, ceiling or wall. Interior or exterior.

DIMENSIONS

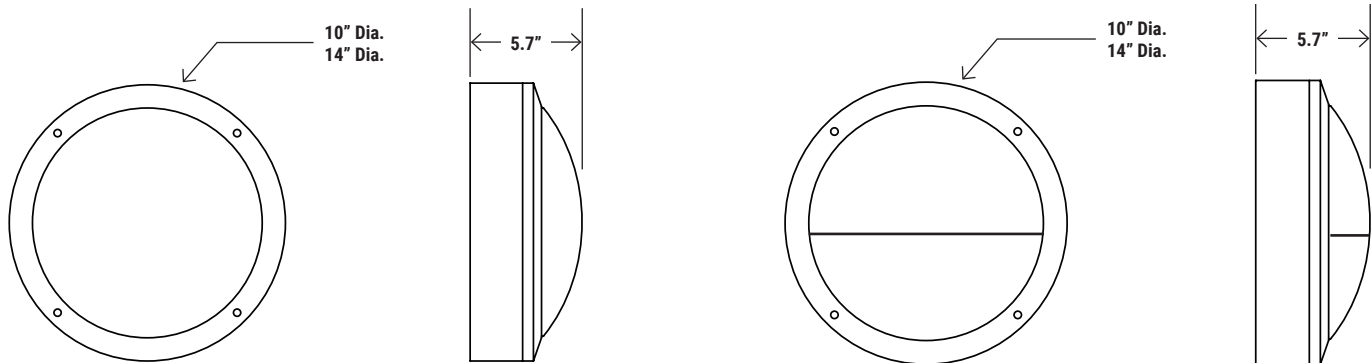

FINISH

Tamper proof T20 Torx stainless screws

Aluminum die-cast body



AVAILABLE ACCESSORIES SOLD SEPARATELY

Tamper proof T20 Torx stainless screws

WITH OPTIONAL VISOR

Aluminum die-cast body

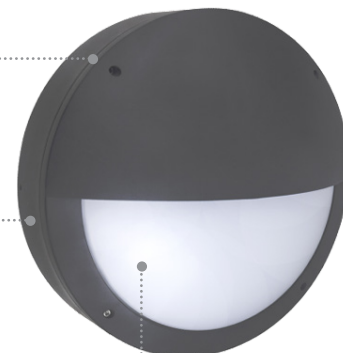

DF-14-VISOR-BK
DF-10-VISOR-BK
Vandal Eyelid Visor

DEFENDER SERIES

Vandal Resistant Luminaire

Type:

Fixture:

PHOTOMETRICS

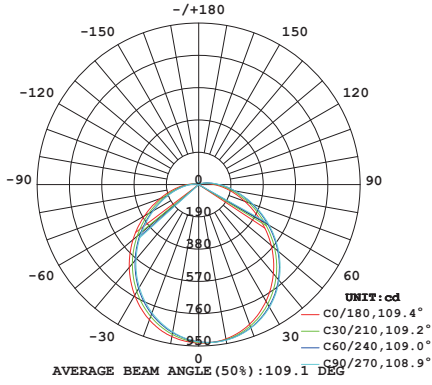

DF-OP-10-25W-30-BK

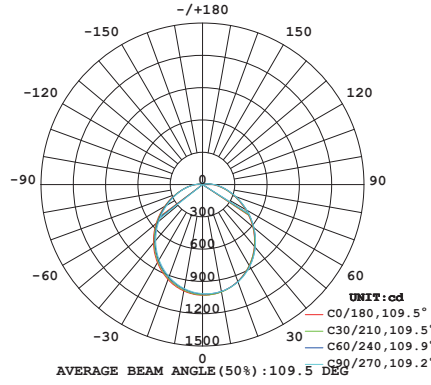

DF-OP-10-25W-40-BK

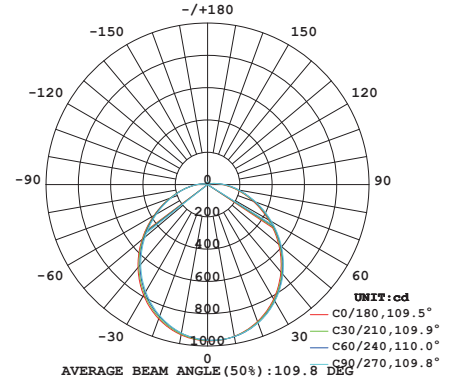

DF-OP-10-25W-50-BK

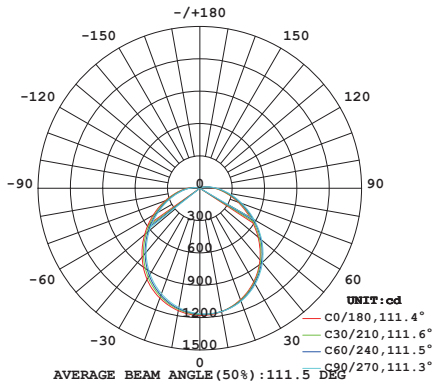

DF-OP-14-30W-30-BK

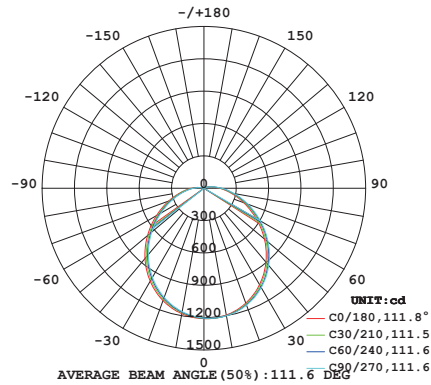

DF-OP-14-30W-40-BK

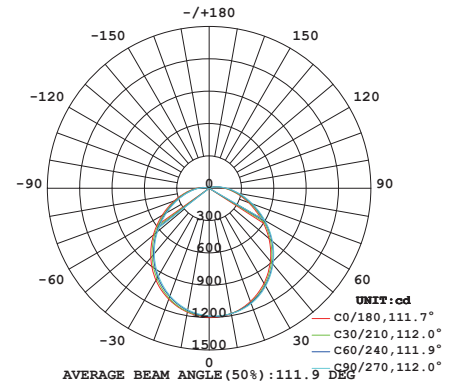

DF-OP-14-30W-50-BK

DEFENDER SERIES

Vandal Resistant Luminaire

Type:

Fixture:

PHOTOMETRICS • OPTIONAL VISOR

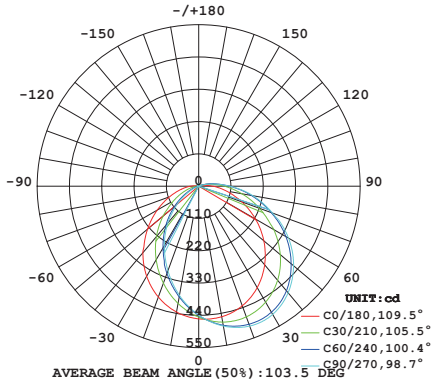

DF-EL-10-25W-30-BK

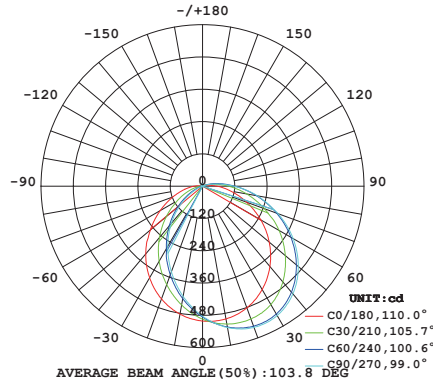

DF-EL-10-25W-40-BK

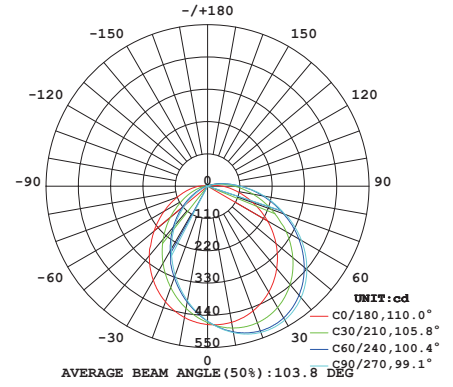

DF-EL-10-25W-50-BK

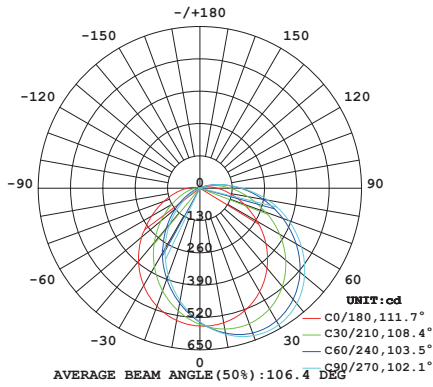

DF-EL-1430W-30-BK

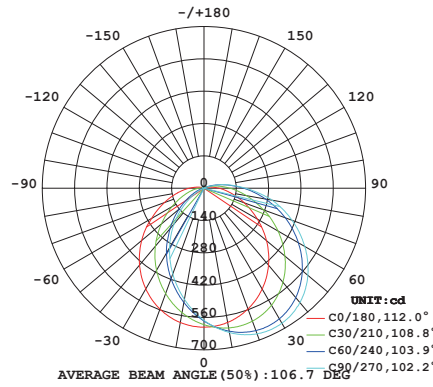

DF-EL-14-30W-40-BK

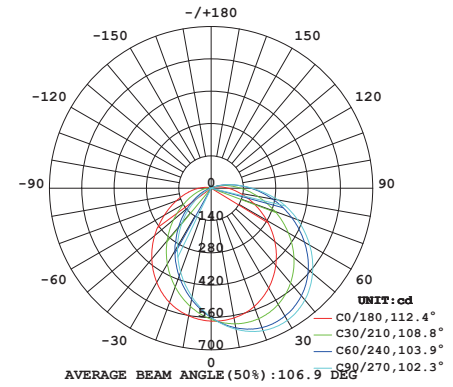

DF-EL-14-30W-50-BK