

RAIL 2 SERIES

Architectural Linear Luminaire

Type:

Fixture:

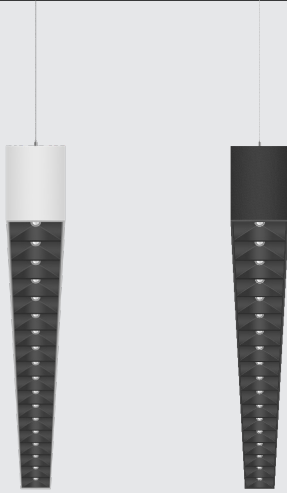

DESCRIPTION

Our Architectural Linear Luminaire is a unique linear series that brings any space to the center stage. The timeless streamlined forms blend well with contemporary decors and modern work spaces. These linear luminaires simply provide wide powerful lighting any atmosphere.

INTENDED USE

Our Rail 2 Series modern aesthetic makes it perfect for a variety of indoor spaces. The pendant is perfect for illuminating offices, entryways, conference rooms, retail spaces, lobbies, and many other applications.



TECHNICAL DATA

PRODUCT	RL2-MR
OPTICS	MICRO REFLECTOR
WATTAGE ADJUSTABLE	2' - 10W/15W/20W 4' - 20W/30W/40W 8' - 40W/60W/80W
LUMENS	UP TO 8800 LM
EFFICACY	UP TO 110LM/W
BEAM ANGLE	UP 150°, DOWN 60°
VOLTAGE	100-277V
CCT	3000K, 3500K, 4000K
LIGHT DISTRIBUTION	ADJUSTABLE BY DIP SWITCH. SEE THIRD PAGE FOR DETAILS.
DIMMING	1-10V
CRI	80
THD	<20%
POWER FACTOR	>0.9
FINISH	WHITE, BLACK

ORDERING INFORMATION:

STANDARD ITEM: **RL2-4-40LC-U-35K-C1-MR-WH-P**

OR CUSTOMIZE BELOW:

- - - - - - - - -

Series	Size	Lumen Package	Voltage	CCT	Control	Optics	Finish	Mounting	EM
RL2 - (Architectural Linear Luminaire)	2 - (2 FT)*	20LC - (10W/15W/20W)*	U - (100 -277V)	30K - (3000K)*	C1 - (1-10V dimming)	MR - (Micro Reflector)	WH - (White)	P - (Pendant) S - (Surface)	EM1 - (WP- CEP-12C- 200VPE1)*
	4 - (4 FT)	40LC - (20W/30W/40W)		35K - (3500K)			BL - (Black)*		
	8 - (8 FT)*	80LC - (40W/60W/80W)*		40K - (4000K)					

*Additional cost and/or lead time on customized fixtures may apply. Some fixtures require an MOQ. Please contact your sales rep for more information.

RAIL 2 SERIES

Architectural Linear Luminaire

Type:

Fixture:

FEATURES

CONSTRUCTION

Extruded aluminum housing.

FINISH

Powder coat black, white finish.

OPTICS

Micro Reflector lens.

ELECTRICAL

Class 2 high efficiency LED driver, with a standard 1-10V driver which continuous dims to 10% that works with many types of controls. Standard electronic drivers are UL recognized and available for 100-277V. Lumen maintenance is L80>50,000 hours.

MOUNTING

Pendant and surface.

*IES Files available upon request

MOUNTING

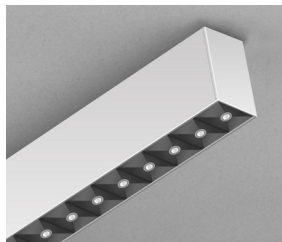

SURFACE - It is the ideal choice for low ceilings and minimal ceiling spaces. Surface mounted luminaires can be used effectively to enhance architectural features.

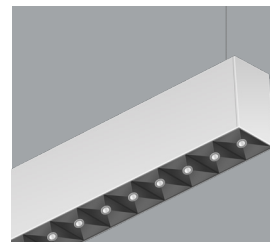

PENDANT - Best suited to spaces with generous ceiling heights. Light up the space to improve comfort with the indirect lighting option.

PENDANT STYLE

Note: Standard Configuration: 1pc 4" canopy+ 1pc 2" canopy
Please specify if need to be custom.

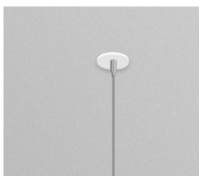

RS-2RC
2 in. Round
Non Power Feed

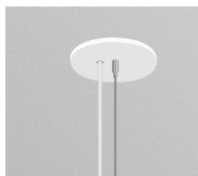

RS-4RC-PF
4 in. Round
Power Feed



RS-2SC
2 in. Square
Non Power Feed



RS-4SC-PF
4 in. Square
Power Feed

DROP CEILING / T-GRID CEILING



T-Grid Clips - Suspending the luminaire in the T-grid. Compatible for various T-grid, including 9/16" Flat, 9/16" Slot, 15/16" Flat

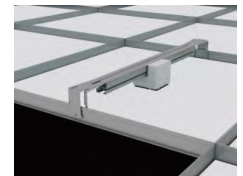

T-Grid Hangers - Suspending the luminaire between the T-grid

JOINERS

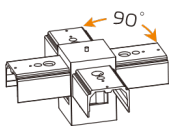

RL2-CRS

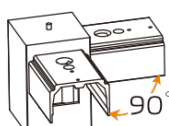

RL2-L



RL2-STR

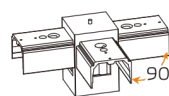

RL2-T

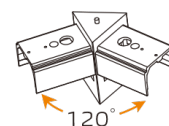

RL2-V



RL2-Y

Joiners are available in **Black** or **White** to match fixture color

RAIL 2 SERIES

Architectural Linear Luminaire

Type:

Fixture:

DIMENSIONS

Product Dimension

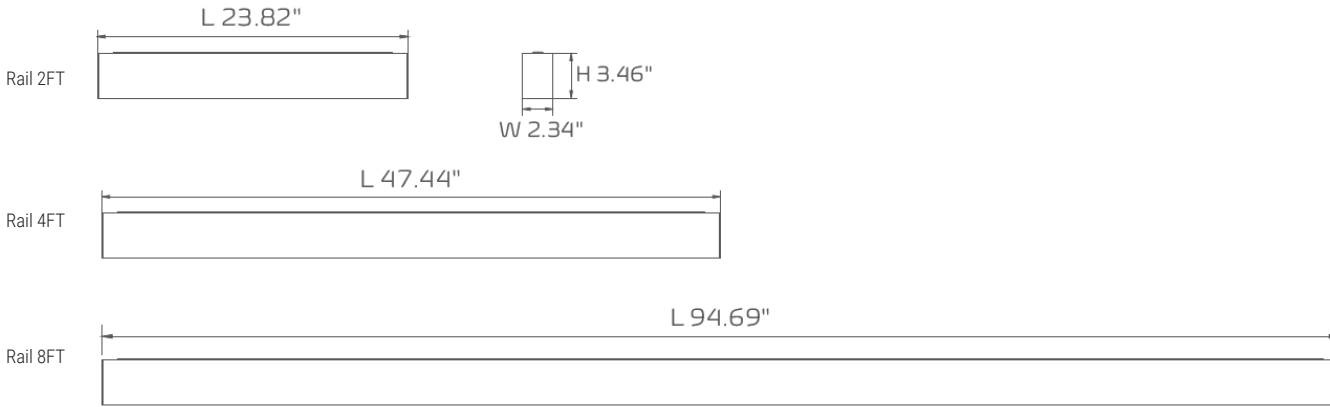

Individual

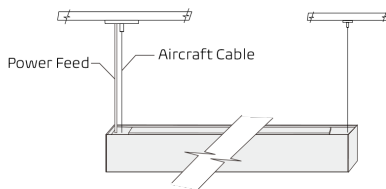

Continuous Run

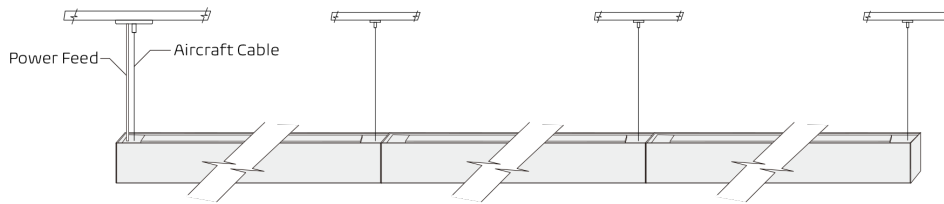

120VAC: connections up to 40ft.
277VAC: connections up to 100ft.

LIGHT DISTRIBUTION

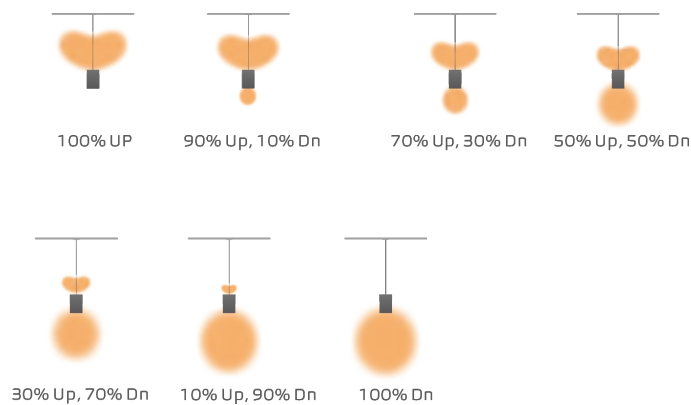

EFFICIENCY

EFFICIENCY	MICRO REFLECTOR
100% up	108 lm/w
90% up, 10% down	108 lm/w
70% up, 30% down	109 lm/w
50% up, 50% down	110 lm/w
30% up, 70% down	101 lm/w
10% up, 90% down	92 lm/w
100% down	83 lm/w