

HOSPITALITY FLUSH-MOUNT SERIES

DOUBLE RING FLUSH MOUNT CUSTOMIZABLE



INSTALLATION MANUAL

PRODUCT PARAMETER	
VOLTAGE	120V
RATING	DAMP LOCATION
FINISH	BRONZE, BRUSHED NICKEL, RAL CUSTOM



PACKAGE CONTENTS:

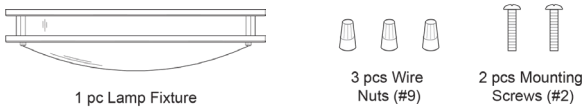

SAFETY INFORMATION

BE SURE THE POWER IS OFF! RISK OF ELECTRICAL SHOCK: Always use the switch to power off. Do not perform any operations while this unit is powered on. The electrical system you want to connect the device to must be grounded. Read the instructions before using or powering this device. The safety instructions must remain with the unit in case of transfer. Any damage to the device linked to an inappropriate use is excluded from support by the warranty. Before connecting, make sure that the current and voltage are compatible with this device. We highly recommend that all installations are made by QUALIFIED ELECTRICIAN. We are NOT responsible by any means for the use or misuse of the following information. We are NOT responsible in whole or part for any harm or damage that may or may not be caused. We reserve the right to revise the components of any product, due to part availability or change ETL, CUL, UL standards without assuming any obligation or liability to modify any products previously manufactured and without notice. These instructions do not cover all details of variations in equipment, nor do they provide every possible contingency to be met. Turn off / unplug power when installing or service device.

PRE - INSTALLATION

- Carefully remove the light fixture, mounting package, from the box and check that all parts are included. Do not attempt to assemble the product if any part is missing or damaged.
 - Always Turn off the power supply before installation.
 - Should be installed by qualified electricians.
 - A loose wire increases the risk of fire; tighten all connections securely.
- Warning: Failure to disconnect the power supply prior to installation may result in serious injury or death.

WARNING

- WARNING:** Read all safety precautions and installation instructions carefully before installing or servicing this fixture. Failure to comply with these instructions could result in a potentially fatal electric shock, fire, and/or property damage.
- All electrical connection must be in accordance with local National Electrical Code(N.E.C) standards.
 - To avoid possibility of electrical shock or fire, the installation personnel must have professional electric knowledge.
 - Turn off electrical power at fuse or circuit breaker box before wiring fixture to the power supply. Turn off the power when you perform any maintenance.
 - If the product is damaged, do not use it.
 - This luminaire is rated for 100-120Vac 50/60Hz only.
 - For indoor use only. Suitable for damp locations.
 - Operating in ambient temperature -20°C to 40°C / -4°F to 104°F.

CLEANING

- Clean the outside of the fixture with a soft, dry cloth or slightly dampened clean cloth. Never use a cleaner with chemicals, solvents, or harsh abrasives to clean the product.
- Do not spray cleaner directly onto any part of the fixture or LEDs as this may permanently damage the light or its functions

INSTALLATION (Caution: Before beginning installation turn off the circuit breaker and light switch)

INSTALLATION DIAGRAM

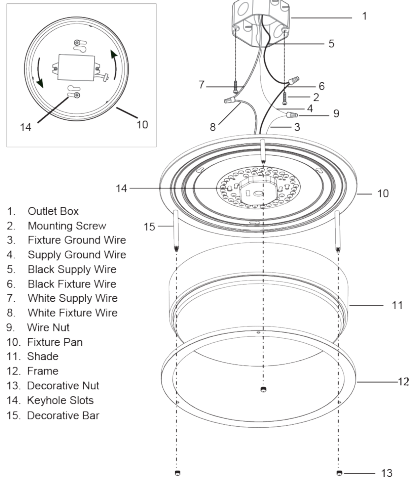

STEP 1

Remove the diffuser by turning 3 decorative nuts (#13) on metal ring anti-clockwise.

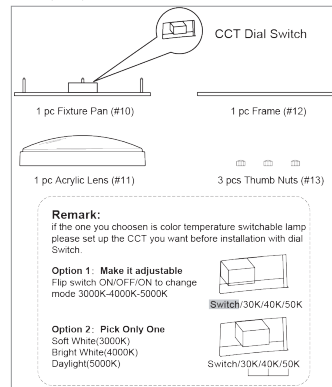

STEP 2

Thread the mounting screws (#2) onto the outlet box (#1), leaving about 1/2_{in} unscrewed.

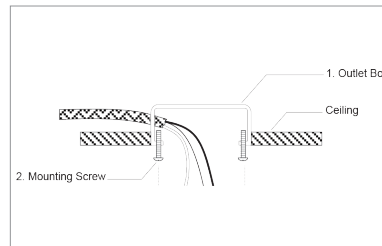

STEP 3

Place the fixture pan (#10) over the outlet box (#1) and onto the mounting screws (#2), making sure they feed through the keyhole slots (#14), rotate the fixture pan (#10) so that the mounting screws (#2) slide into the narrow ends of the keyhole slots (#14)

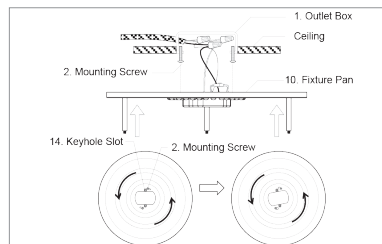

STEP 4

Connect wire by wire nuts (#9) then put the wires into the outlet box (#1).

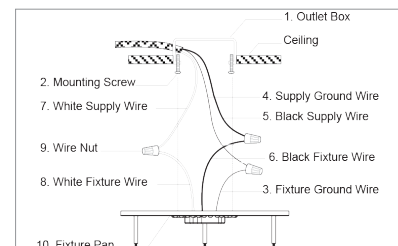

STEP 5

Align diffuser on canopy, then place the metal ring on diffuser, let 3 decorative bars (#15) come out of the metal ring. Twist 3 decorative nuts (#13) on top clockwise to tighten the ring and diffuser. Installation is complete. Turn on the power.

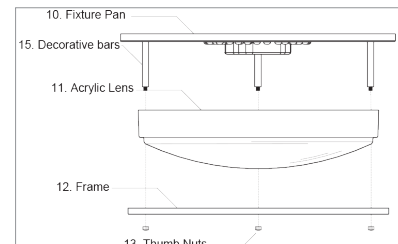

IF YOU CHOOSE THE FOURTH "SWITCHABLE MODE"

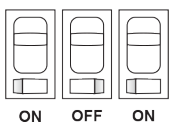

Flip wall switch/dimmer switch On/Off/On under 3 seconds to change mode 3000K-4000K-5000K