

DEFENDER SERIES

OPEN STYLE VANDAL RESISTANT LUMINAIRE

INSTALLATION MANUAL

PRODUCT PARAMETER

INPUT VOLTAGE	100 - 277V
MATERIAL	DIE-CAST ALUMINUM
WORKING TEMP	-40°F-131°F / 32°F-122°F(EM)

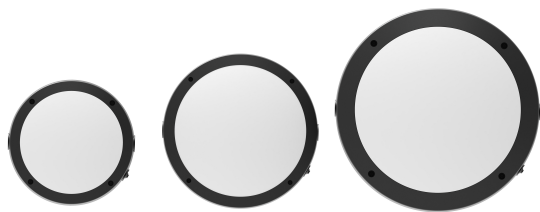

PRE - INSTALLATION

- Carefully remove the fixture from the carton.
- Before beginning assembly, installation, or operation of product, make sure all parts are present. Compare parts with package contents list and diagram on previous page. If any part is missing or damaged, do not attempt to assemble, install or operate the product. Contact customer service for replacement parts.
- Tools required for assembly (Not Included): screwdriver, phillips screwdriver, pliers, electrical tape, wire cutters, safety glasses, ladder, wire stripper.

SAFETY INFORMATION

BE SURE THE POWER IS OFF! RISK OF ELECTRICAL SHOCK: Always use the switch to power off. Do not perform any operations while this unit is powered on. The electrical system you want to connect the device to must be grounded. Read the instructions before using or powering this device. The safety instructions must remain with the unit in case of transfer. Any damage to the device linked to an inappropriate use is excluded from support by the warranty. Before connecting, make sure that the current and voltage are compatible with this device. We highly recommend that all installations are made by QUALIFIED ELECTRICIAN. We are NOT responsible by any means for the use or misuse of the following information. We are NOT responsible in whole or part for any harm or damage that may or may not be caused. We reserve the right to revise the components of any product, due to part availability or change ETL, CUL, UL standards without assuming any obligation or liability to modify any products previously manufactured and without notice. These instructions do not cover all details of variations in equipment, nor do they provide every possible contingency to be met. Turn off / unplug power when installing or service device.

WARNING

- WARNING:** Read all safety precautions and installation instructions carefully before installing or servicing this fixture. Failure to comply with these instructions could result in a potentially fatal electric shock, fire, and/or property damage.
- Turn off the electrical power at the fuse or circuit breaker box before installing or servicing any part of this fixture
 - If replacing a fixture, remove existing fixture and make a sketch of wiring configuration (by color) or mark wires with masking tape for identification
 - Remove the lamp bas and diffuser from the carton and check that all parts are included. Be careful not to misplace any of screws or parts needed for installing the fixture
 - Diffuser is fragile. Carefully set aside in a safe location to avoid damage until ready to be installed.

FCC WARNING

- WARNING:** Changes or modifications to this unit not expressly approved by the party responsible for compliance could void the user authority to operate the equipment.
- NOTES:** This equipment has been tested and found to comply with the limits for a Class B digital device, pursuant to Part 15 of the FCC Rules. These limits are designed to provide reasonable protection against harmful interference in a residential installation. This equipment generates, uses and can radiate radio frequency energy and, if not installed and used in accordance with the instructions, may cause harmful interference to radio communications. However, there is no guarantee that interference will not occur in a particular installation. If this equipment does cause harmful interference to radio or television reception, which can be determined by turning the equipment off and on, the user is encouraged to try to correct the interference by one or more of the following measures:
- Reorient or relocate the receiving antenna.
 - Increase the separation between the equipment and receiver.
 - Connect the equipment into an outlet on a circuit different from that to which the receiver is connected.
 - Consult the dealer or an experienced radio/TV technician for help.

Hardware Included



AA: Small Pin Cross Machine Screws (2) BB: Wire Nuts (3)

CC: EVA Gasket (1)

DD:

PACKAGE CONTENTS

Part	Description	Quantity
A	Fixture	1
B	Lens	1
C	Fixture ring	1

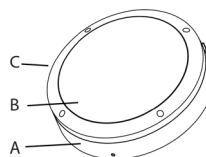

WALL MOUNT INSTALLATION (Caution: Before beginning installation turn off the circuit breaker and light switch)

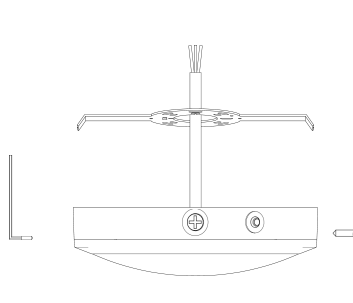

STEP 1
Removing screws to take out the mounting bracket.

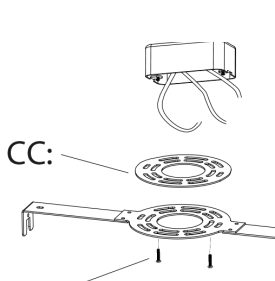

STEP 2
Stick EVA gasket to the mounting bracket, fasten it to the J-box.

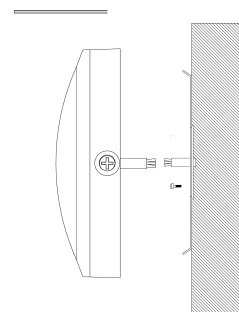

STEP 3
Hanging the fixture to mounting bracket and lock the screws.

DEFENDER SERIES

OPEN STYLE VANDAL RESISTANT LUMINAIRE

Spitzer
LIGHTING

INSTALLATION MANUAL

COLOR TEMPERATURE SELECT

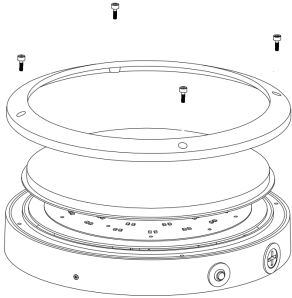

STEP 1
Removing screws to take out the fixture ring and lens.

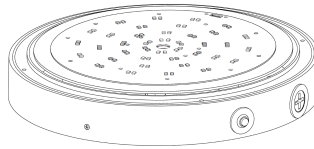

STEP 2
Select the color for 30K, 40K, & 50K.

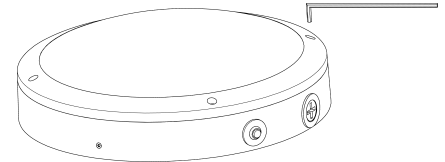

STEP 3
Fasten the screws

VISOR INSTALLATION

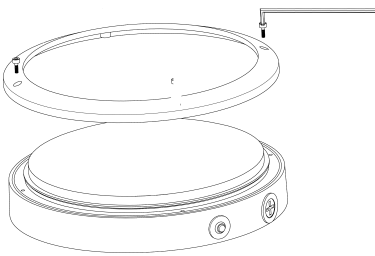

STEP 1
Removing screws to take out the fixture ring.

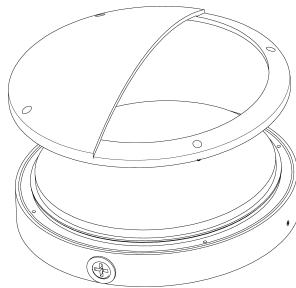

STEP 2
Replace the new fixture ring with visor.

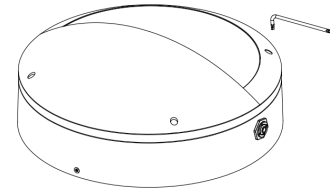

STEP 3
Fasten the screws.

WIRING DIAGRAM (Caution: Before beginning installation turn off the circuit breaker and light switch)

A. REGULAR FIXTURE WIRING



B. WITH EMERGENCY FIXTURE WIRING

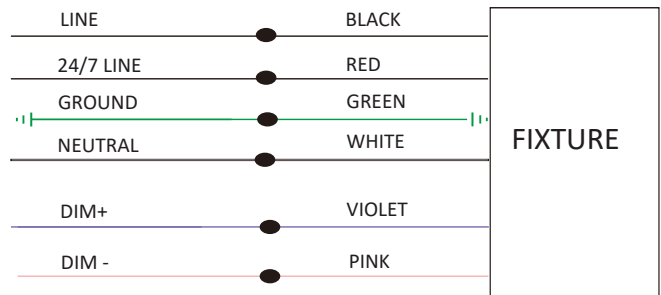

TROUBLE SHOOTING

PROBLEM	POSSIBLE CAUSE	SOLUTION
Light will not come on	A. Light switch is turned off. B. Fuse is blown or circuit breaker is turned off. C. Incorrect circuit wiring	A. Turn light switch on B. Replace fuse or turn circuit breaker on C. Verify that fixture is wired properly

CARE AND MAINTENANCE

CAUTION: Before attempting to clean the fixture, disconnect the power to the fixture by turning the breaker off or removing the fuse from the fuse box. This LED light fixture is made from quality materials that will last many years with minimum care and maintenance. You may want to clean the fixture with a soft cloth periodically. To maintain the best appearance of the fixture, do not use cleaners with chemicals, solvents or harsh abrasives. Do not use liquid cleaner on the LEDs, LED driver, or wiring inside the light fixture.